

Bioclimatic  
Pergolas  
P-190  
P-150



**saxun**<sup>°</sup>  
Your world, our universe.

Saxun contributes to the well-being and happiness of people through solutions that improve the spaces in your life. We are in love with spaces and the possibilities they offer us to help us feel good. That's why we develop products that are functional, versatile and comfortable, so that you can make the most of your space in a variety of ways.





# Sharing unique moments

Creating - or making the most of - new spaces to enjoy with the family, or expanding the possibilities of your restaurant throughout the year, regardless of the heat or cold, rain or snow, are some of the privileges that we're not going to give up nowadays.

Saxun offers you the most successful solution, with the best market potential when it comes to enjoying your terrace or garden as though it were another living room in your home.

Our P-190 and P-150 bioclimatic pergolas allow you to enjoy outdoor living all year round, regulating the temperature of the room in a natural way, while protecting it from changes in the weather.

Robust sun protection and enclosure systems that are easy to install, require a minimum amount of maintenance and have a long service life.

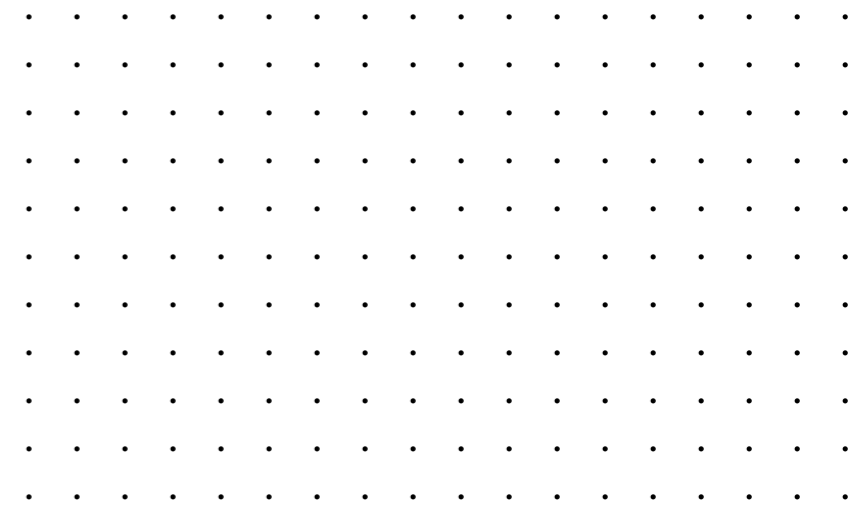

# High performance protection

The P-190 and P-150 bioclimatic pergolas are robust sun protection systems that protect from the rain and provide pleasant ventilation to the space created.

Structures that are easy to install and require virtually no maintenance.



Total protection against solar radiation and rain.



Moveable slats from 0 to 135°.



The movement of the slats is motorised.



Simple and convenient operation by means of the latest generation of transmitters and automated systems.



Patented perimeter sealing system for rain and light.



Modular system with great customisation possibilities.



LED lighting in the perimeter area and/or in slats.



Bluetooth sound system. Speakers built into the structure.



Infrared heater for the coldest days.



It allows the addition of other Saxun systems, such as awnings, glass sliding windows, drop awnings, window and door shutters...



Top quality aluminium and stainless steel components.

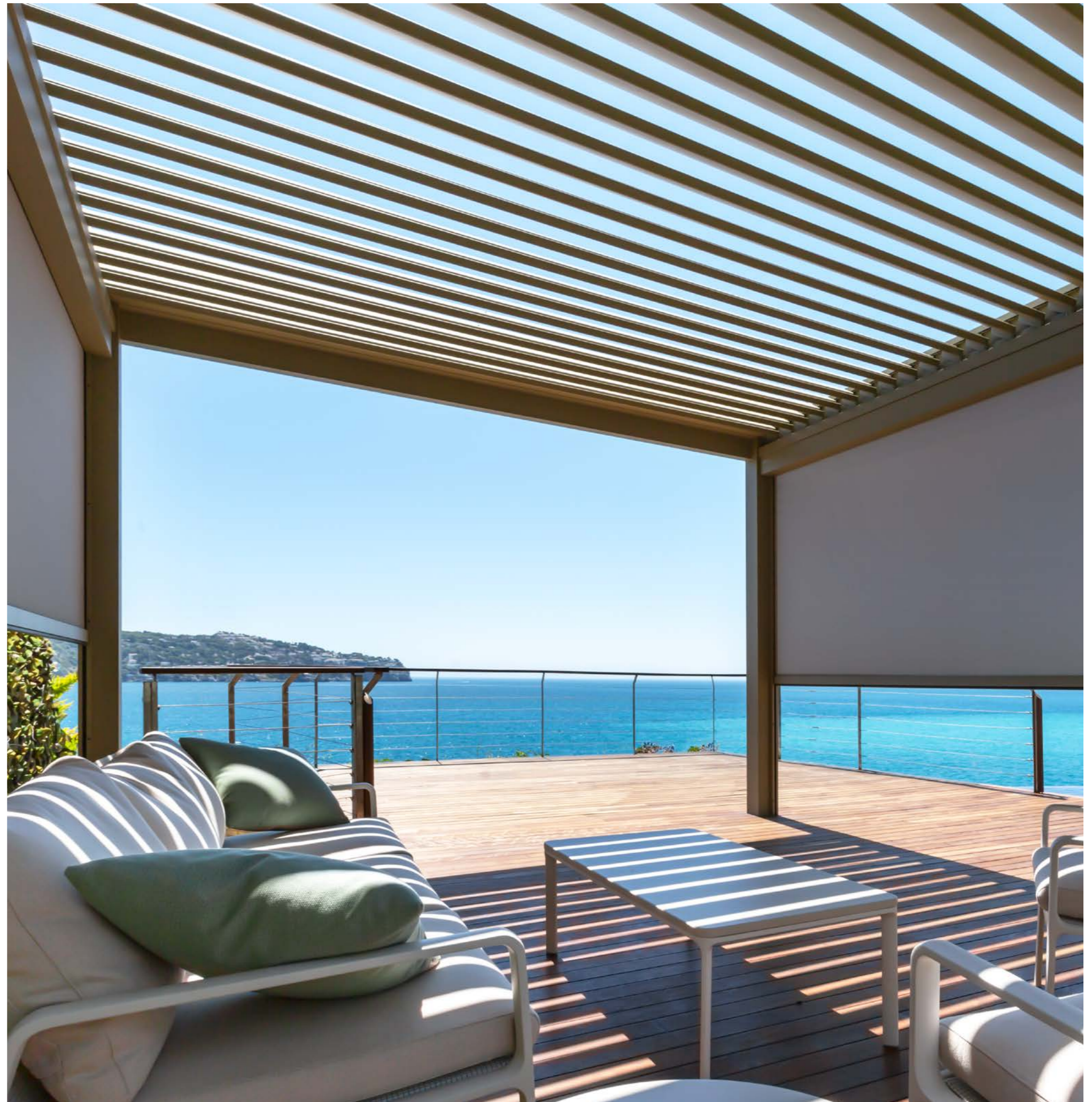



# Bioclimatic effect

The slats of our bioclimatic pergolas rotate from a closed position to an open position, up to 135°.

The system generates pleasant natural ventilation by heating the louvres when they are exposed to solar radiation. This produces a natural convection movement of air from the bottom up, through the slats.

An adjustable effect by turning the slats, with which we also control the entry of the desired sunlight into the space created by the pergola itself.

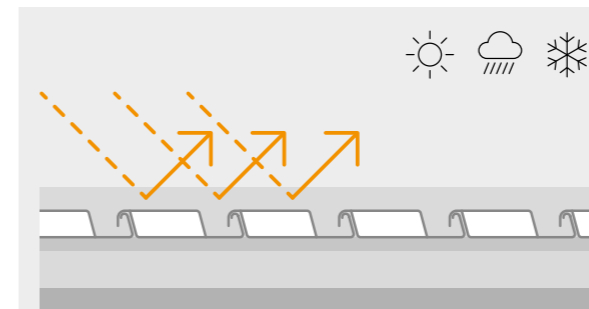

**0°** The roof is sealed and provides total protection against the most harmful solar radiation, as well as the most extreme weather conditions.

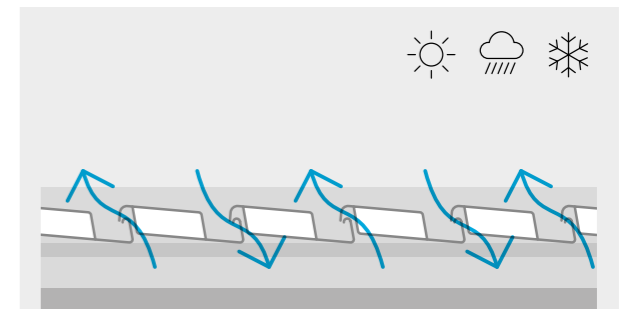

**5°** It permits excellent room ventilation, maintaining shade when it is sunny, or protecting against water when it rains.

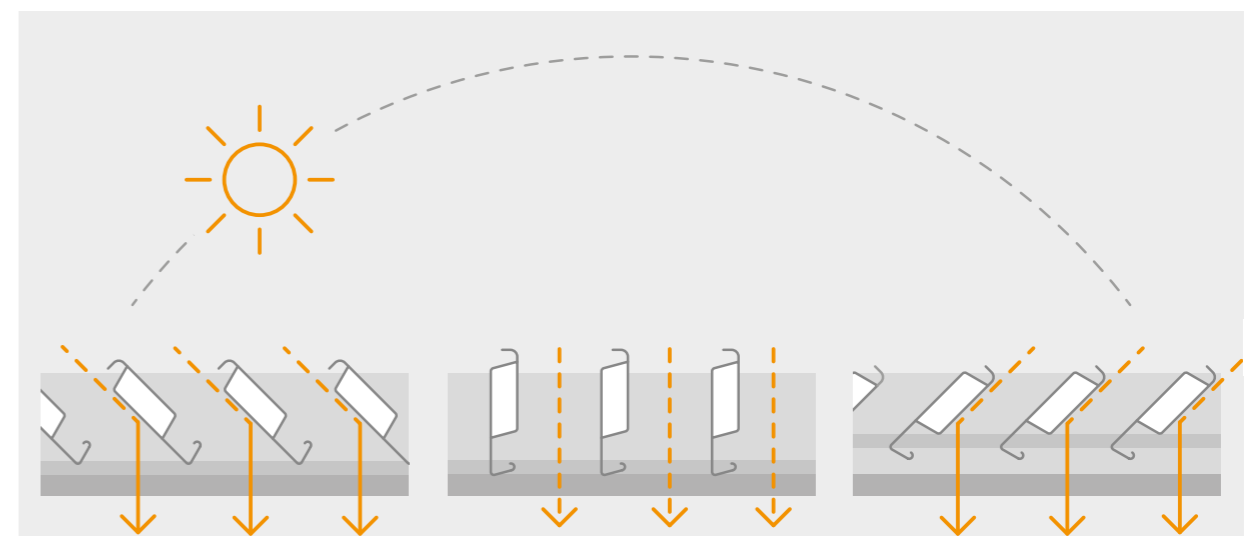

**45°** Enjoy natural ventilation, controlling the direction of the sun's rays and their intensity.

**90°** Opening the slats allows full use of the light, even when it is scarce.

**135°** Maximum inclination that lets sunlight come through even when it starts getting dark.

**Bioclimatic Pergola**

# P-190 and P-150

The bioclimatic pergola is a sun protection system with a clean-lined design that can be adapted to all architectural styles.

The system is based on a ceiling of adjustable slats made of extruded aluminium. The slats rotate from 0° to 135° thanks to the pivoting shafts inserted in the ends of the slats, which are driven by a 24 VDC mechanical motor. They are operated by means of an extruded aluminium plate.

This mobile roof is mounted on an extruded aluminium structure that allows endless possibilities of modulation, offering optimum resistance to rain and snow loads.

**Collecting rainwater**

The design of our pergolas' slats allows rainwater to be collected in order to reuse it. Water is channelled towards the lateral frames, without needing a slope to drain.

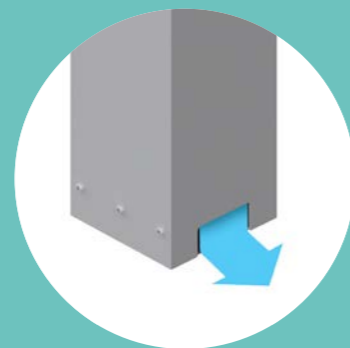

**Waterproof system**

The slats contain a rubber seal that ensures the waterproofing of the pergola, as the seal does not allow water into the joints between the slats. At the same time, it cancels the noise created between the slats due to vibration caused by wind.

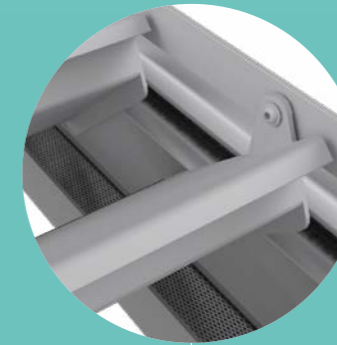

**Registered perimeter seal**

A registered system that acts against sideways rain and that also does not allow direct light and/or reflected light to pass through the joints between the slats, or between the slats and the frame.



**Motorised operation**

The pergola can be operated only by motorisation, using a 24 VDC motor with IP 67 protection. This will also ensure your safety against electric shock, with the additional safety of earthing protection.





## Collecting rainwater

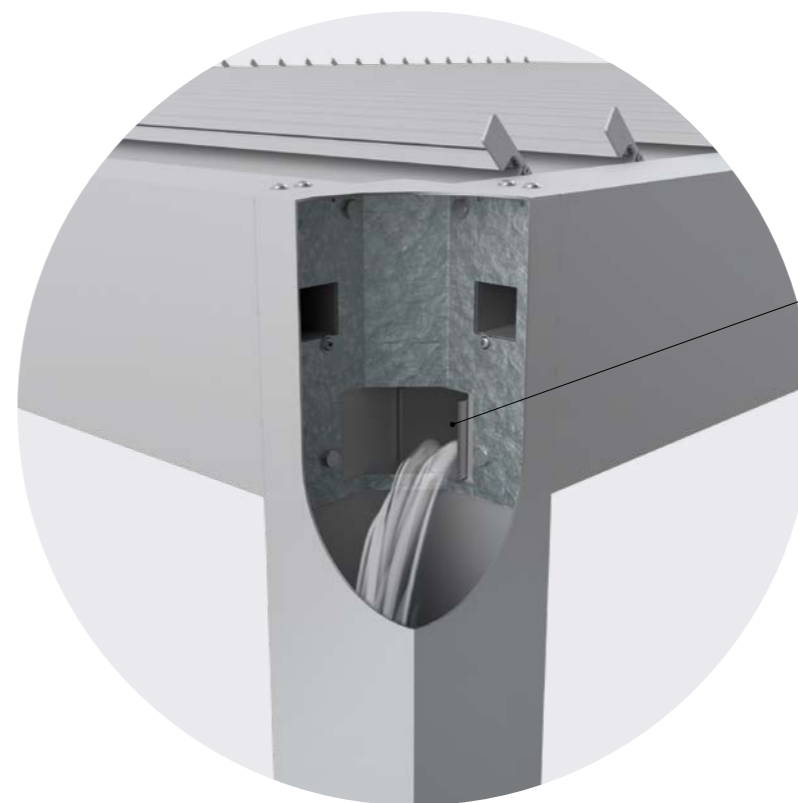

The design of the P-190 and P-150 slats allows rainwater to be collected in order to reuse it.

Water is channelled towards the frames, without needing a slope to drain.

The profiles form a channel that guides the water through them.

### Free-flow drainage

In the case of free-flow drainage, water is expelled freely by means of two columns towards the surface where the pergola is mounted, through the holes for this purpose.

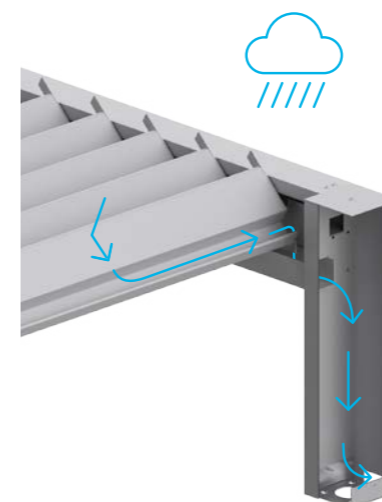

### Slab channel drainage

The built-in channelling inside allows rainwater to be evacuated and then recovered later. The pre-installed draining pipes must be taken into account during the construction of the slab, prior to mounting the pergola.

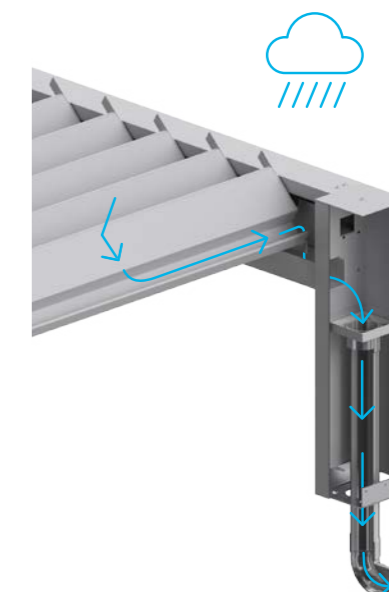





# P-190

## Bioclimatic Pergola

It has endless modulation possibilities, which added to the quality of its materials makes it the perfect solution for solar protection, ideal for adapting and enhancing every architectural style where it is installed.



### Maximum dimensions

- A** Maximum tested width
- B** Maximum tested length
- C** Maximum height
- D** Beam dimensions
- E** Beam dimensions
- F** Column dimensions
- G** Minimum inclination
- H** Type of drainage

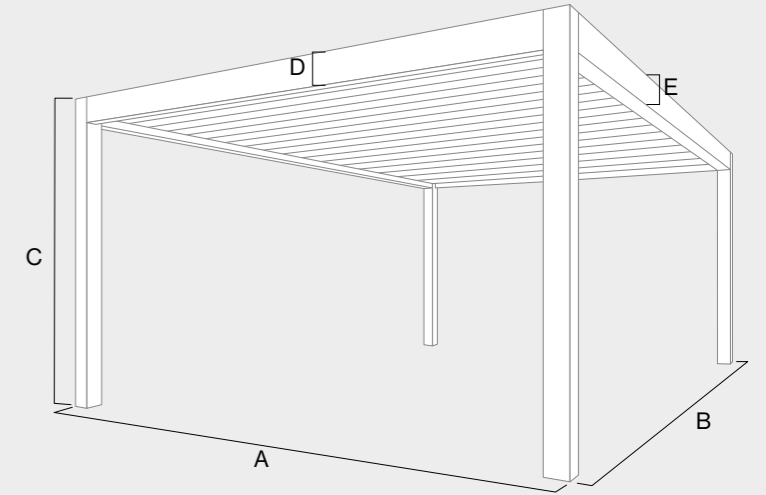

Table of maximum dimensions according to type of Bioclimatic Pergola

	4 Columns	3 Columns	2 Columns		DUPLEX		No Columns
			Parallel to wall	Perpendicular to wall	2 columns	4 columns	
A	4,200 mm	4,200 mm	4,200 mm	4,200 mm	7,000 mm	7,000 mm	4,200 mm
B	6,200 mm	6,200 mm	6,200 mm	6,200 mm	6,000 mm	6,000 mm	6,200 mm
C	3,000 mm	3,000 mm	3,000 mm	3,000 mm	3,000 mm	3,000 mm	-
D	220 mm	220 mm	220 mm	220 mm	282.5 mm	282.5 mm	220 mm
E	220 mm	220 mm	220 mm	220 mm	220 mm	220 mm	220 mm
F	150x150 mm	150x150 mm	150x150 mm	150x150 mm	150x150 mm	150x150 mm	-
G	0%	0%	0%	0%	0%	0%	0%
H	Free-flow or slab channelling.						To be done by client

### Tests

Our pergolas, just like the rest of our products, are subjected to a variety of tests in our labs in order to check their resistance and behaviour under every type of circumstance.

#### Test results

☁️ Wind load EN 13659	<b>Class 6</b>
☔ Rain load EN 12056-3	<b>108 l · m<sup>2</sup>/h (structure and slats)</b>
❄️ Snow load EN 1999 Eurocode 9	<b>100 kg/m<sup>2</sup></b>

# Features

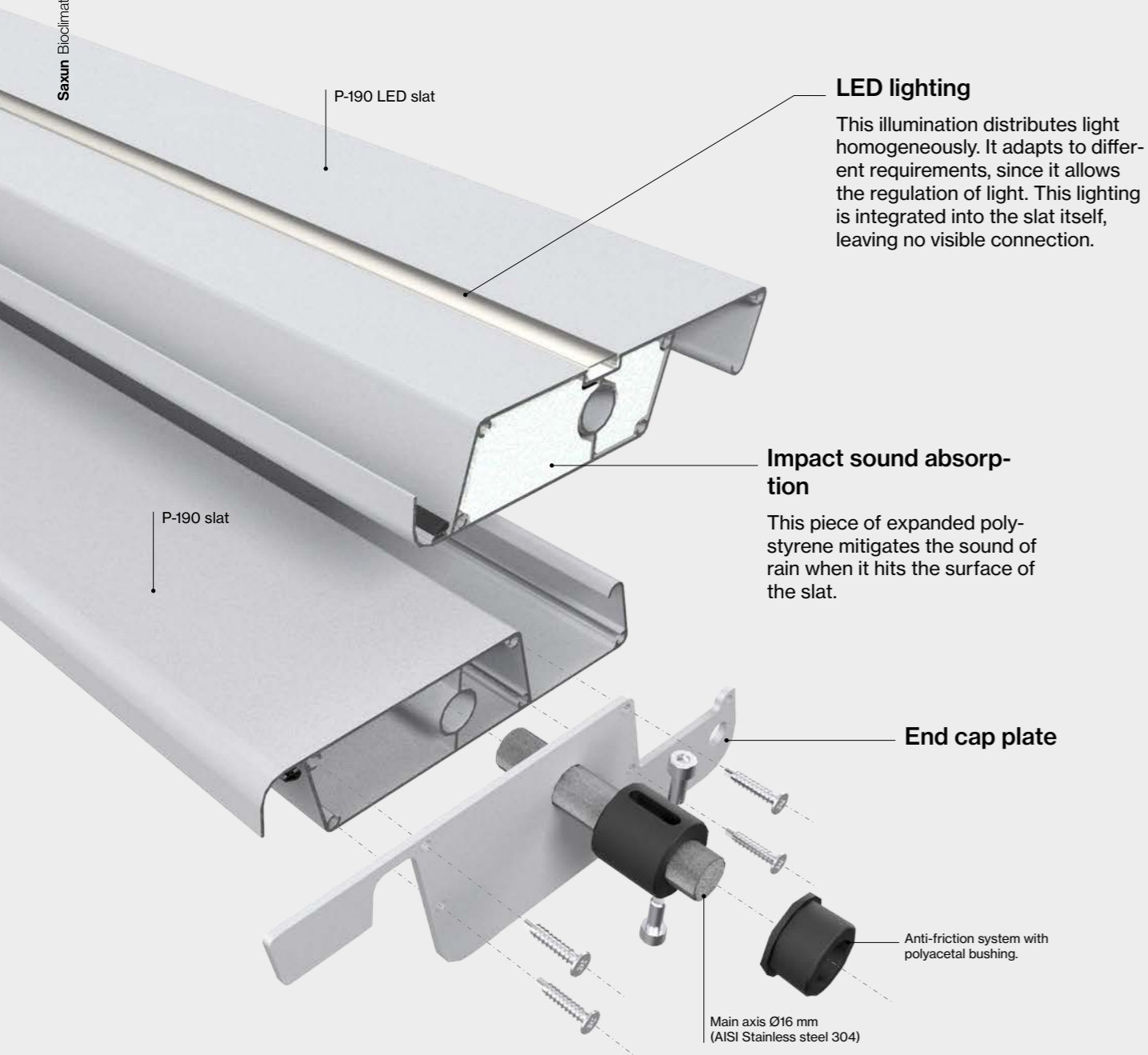

## Motor

The motorised element is discretely hidden between the slats and the frame, enhancing the beauty of the pergola.



# Profiles

## Slats

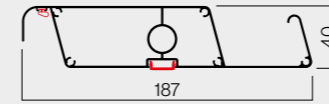

P-190 LED slat  
050189

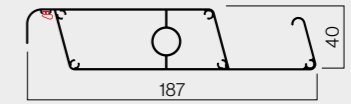

P-190 slat  
050188

## Beams

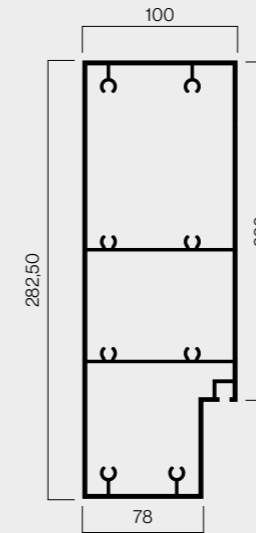

Beam  
P-282,50x100  
Front duplex pergola  
050496

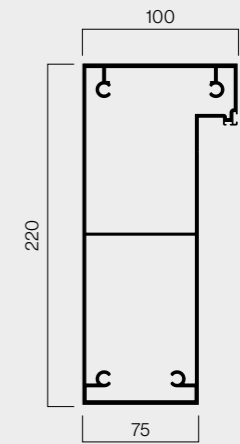

Beam P-220x100  
Pergola simplex and  
duplex lateral  
023103

## Columns

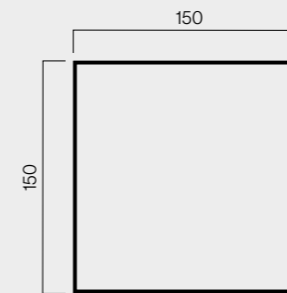

Column  
P-150x150x2.5  
023101

## Adapters

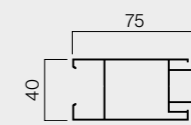

Clip-on adapter  
40x75  
050327

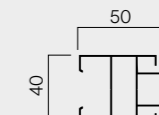

Clip-on adapter 40x50  
SOFT  
050218

## Profiles

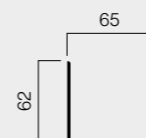

Profile "U"  
62x65x2.5  
050155



Transmission plate  
30x4  
507162

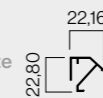

Perimeter  
LED profile  
050491

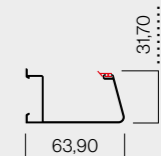

Clipping  
collector  
050208

\* Measurements in mm.



# P-150

## Bioclimatic Pergola

Very advantageous when it comes to installation. Installation time is minimised, making it a quick and easy task, since some profiles simply clip into place and do not need screws.

The mounting of the slats is also smoother, thanks to the retracting spring-loaded shaft.

## Maximum dimensions

- A** Maximum tested width
- B** Maximum tested length
- C** Maximum height
- D** Beam dimensions
- E** Beam dimensions
- F** Column dimensions
- G** Minimum inclination
- H** Type of drainage

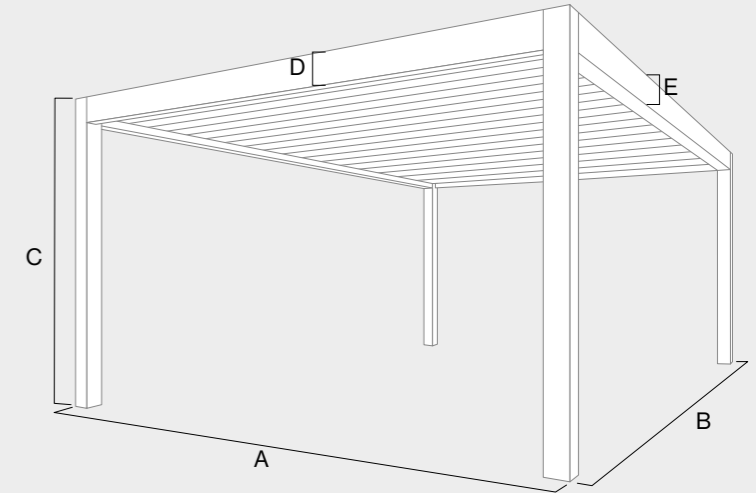

Table of maximum dimensions according to type of Bioclimatic Pergola

	4 Columns	3 Columns	2 Columns	DUPLEX		No Columns
			Parallel to wall	2 columns	4 columns	
A	3,600 mm	3,600 mm	3,600 mm	6,000 mm	6,000 mm	3,600 mm
B	5,000 mm	5,000 mm	5,000 mm	5,000 mm	5,000 mm	5,000 mm
C	3,000 mm	3,000 mm	3,000 mm	3,000 mm	3,000 mm	-
D	180 mm	180 mm	180 mm	242.50 mm	242.50 mm	180 mm
E	180 mm	180 mm	180 mm	180 mm	180 mm	180 mm
F	150x150 mm	150x150 mm	150x150 mm	150x150 mm	150x150 mm	-
G	0%	0%	0%	0%	0%	0%
H	Free-flow or slab channelling.					To be done by client

## Tests

Our pergolas, just like the rest of our products, are subjected to a variety of tests in our labs in order to check their resistance and behaviour under every type of circumstance.

### Test results

☁️ Wind load EN 13659	<b>Class 6</b>
☔ Rain load EN 12056-3	<b>108 l · m<sup>2</sup>/h (structure and slats)</b>
❄️ Snow load EN 1999 Eurocode 9	<b>65 kg/m<sup>2</sup></b>

# Features

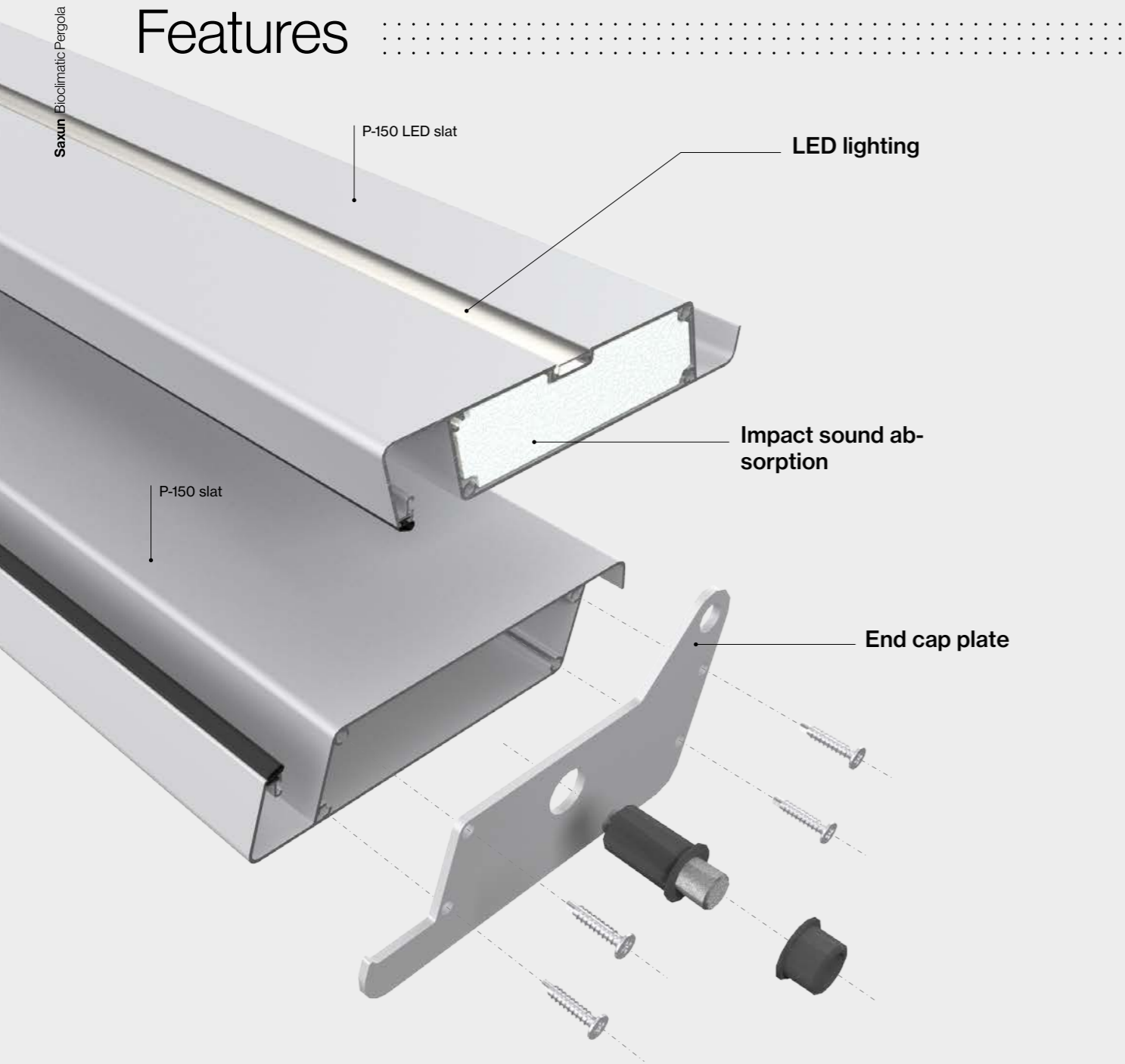

## Motor

In this model, the motor is located in the upper part of the pergola, on the outside, so it is not visible from inside.

This arrangement makes it possible to share a motor when there are groups of pergolas, or in duplex pergolas.

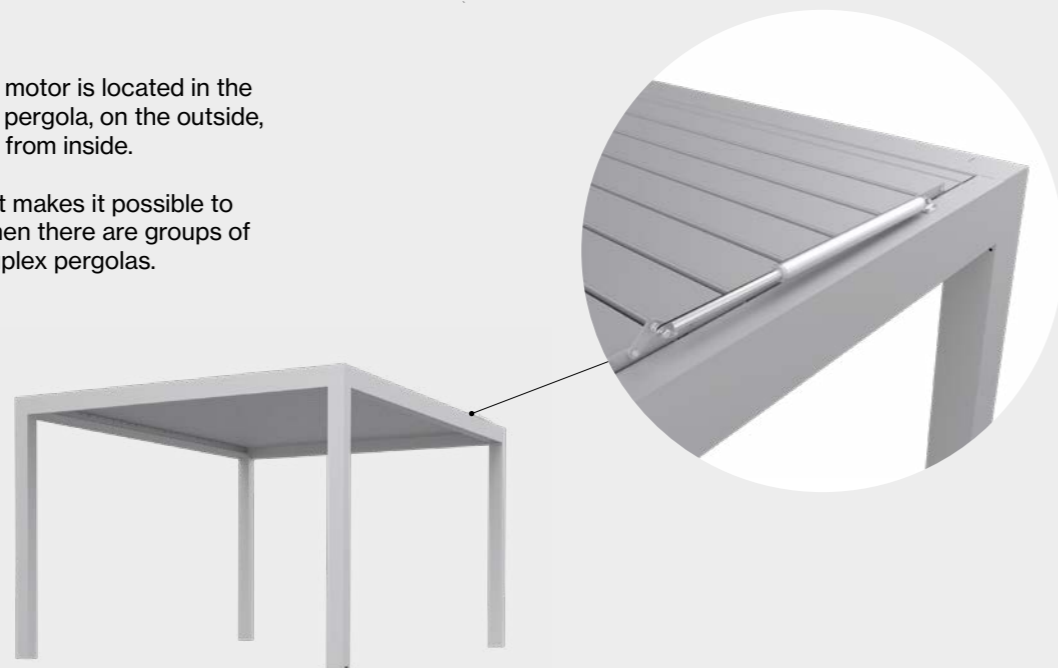

# Profiles

## Slats

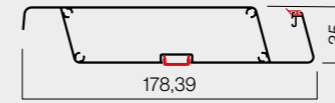

P-150 LED slat  
050210

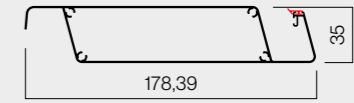

P-150 slat  
050209

## Beams

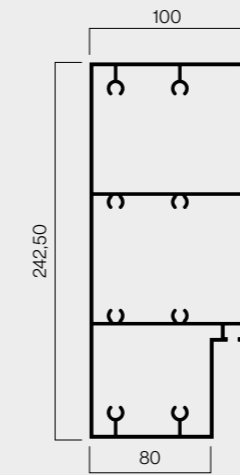

Beam  
P-242,50x100  
Front duplex pergola  
050249

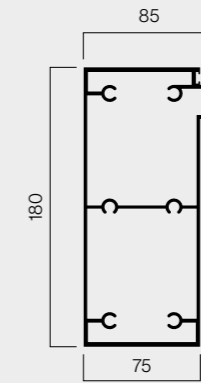

Beam P-180x85  
Pergola simplex and  
duplex lateral  
050206

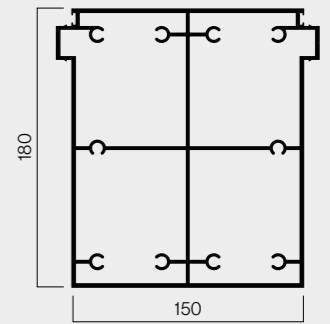

Double beam  
P-180x150  
Duplex central pergola  
050485

## Columns

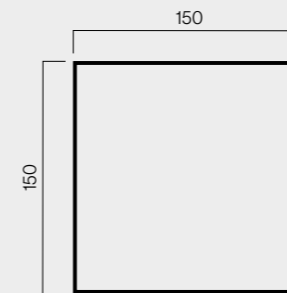

Column  
P-150x150x2.5  
023101

## Adapters

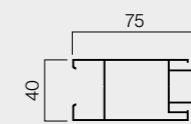

Clip-on adapter  
40x75  
050327

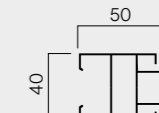

Clip-on adapter 40x50  
SOFT  
050218

## Profiles

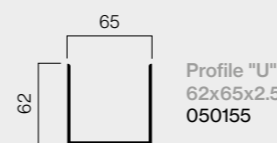

Profile "U"  
62x65x2.5  
050155



Transmission plate  
profile  
30x4  
507162

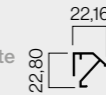

Perimeter  
LED profile  
050491

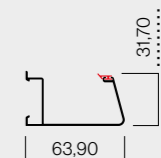

Clipping  
collector  
050208

\* Measurements  
in mm.

# Types of assembly

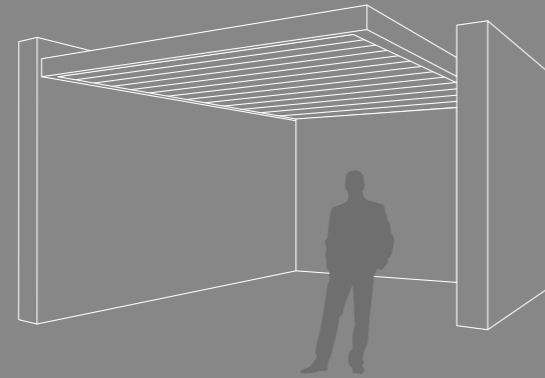

● Bioclimatic pergola  
**no columns**

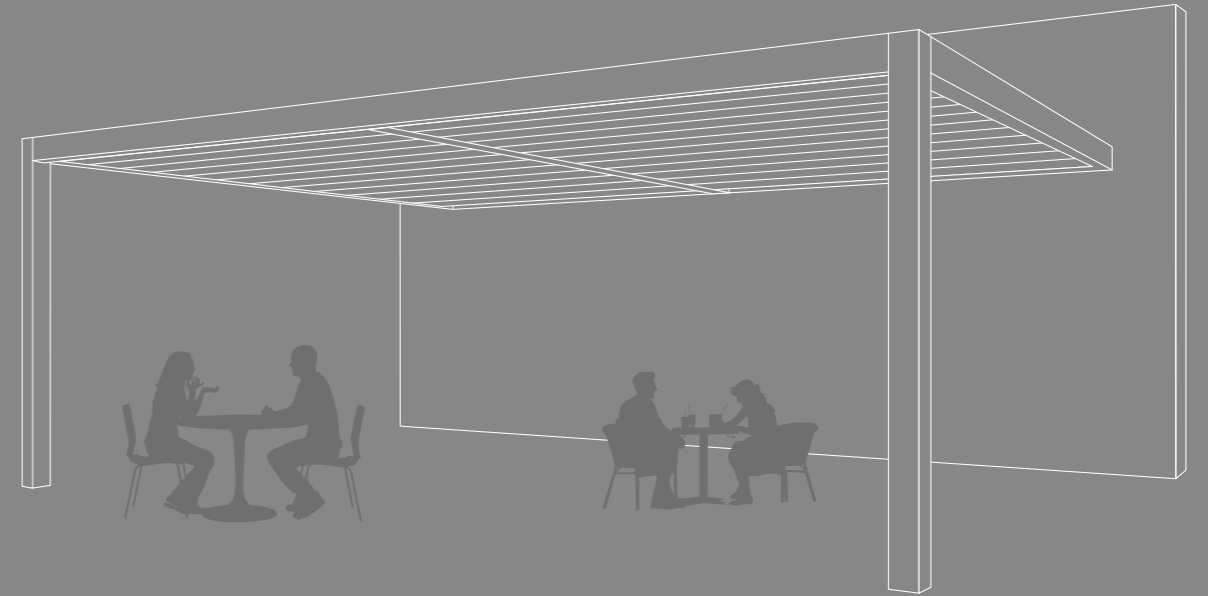

● Bioclimatic Pergola  
**2 duplex columns**

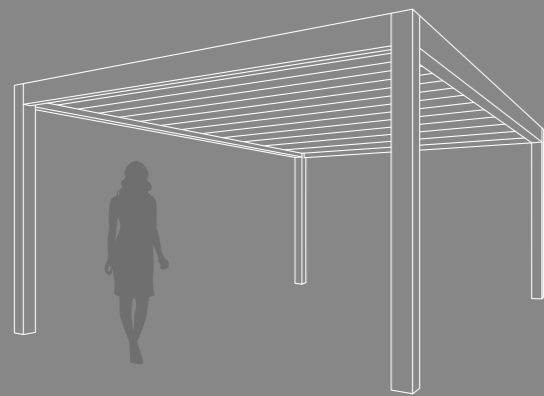

● Bioclimatic pergola  
**4 columns**

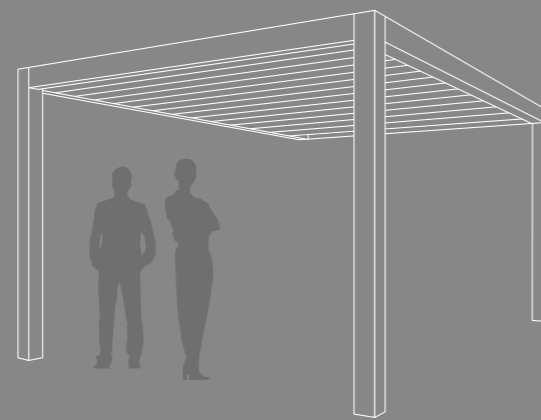

● Bioclimatic pergola  
**3 columns**

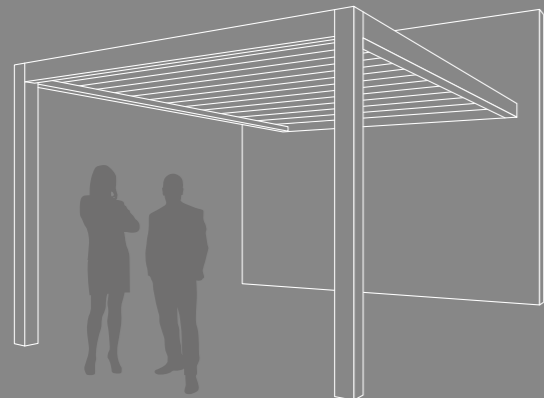

● Bioclimatic Pergola  
**2 columns with parallel slats**

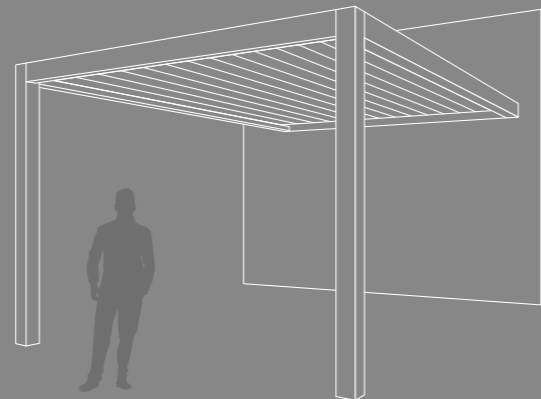

● Bioclimatic Pergola  
**2 columns with perpendicular slats**

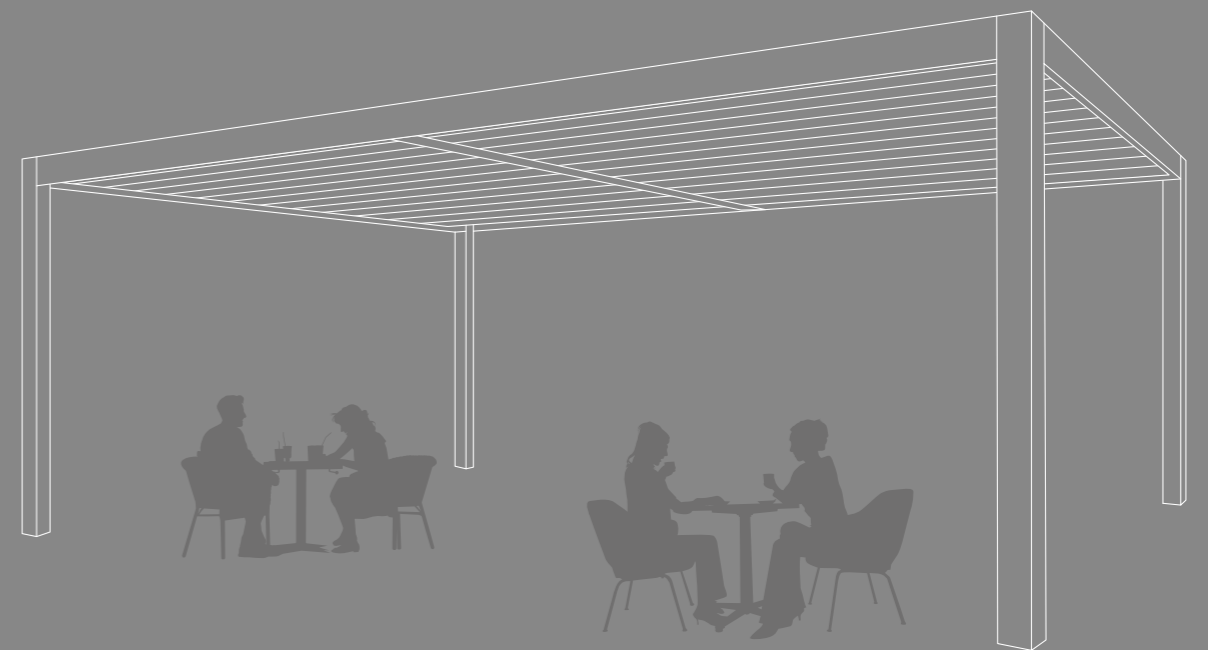

● Bioclimatic Pergola  
**4 duplex columns**

# Customised configuration

Terraces, patios and gardens of all types of homes, restaurants and hotels enjoy outdoor spaces protected with Saxun, thanks to the endless possibilities offered by P-190 and P-150.

The proven experience of our Technical Office provides you with the advice you need to find the right solution for each space.



## Examples of custom installations

Duplex pergolas sharing columns

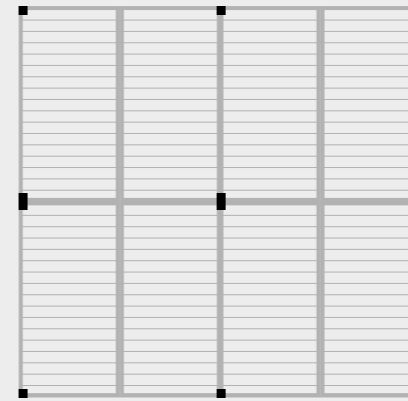

Pergolas combining movable and fixed slats



Fixed slats

Pergolas without sharing columns

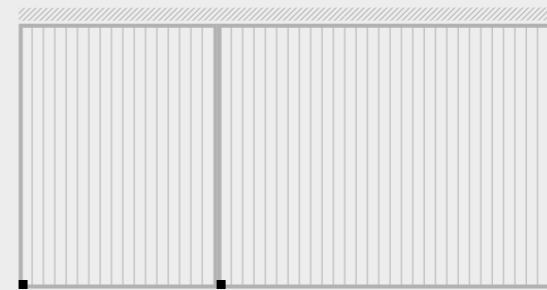

Pergola sharing columns with central steel structure

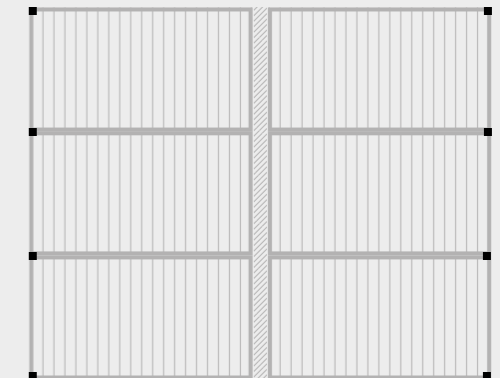

Pergolas with offset columns



Pergolas with offset beams

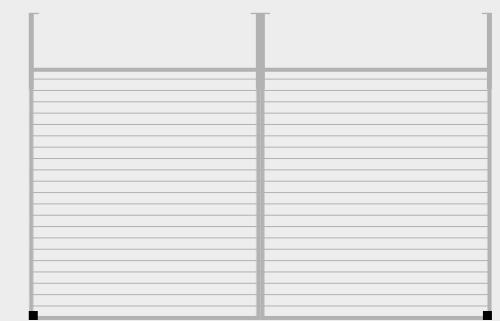

# Great allies of hoteliers

Our bioclimatic pergolas are a safe bet for all types of projects in the HORECA sector, whether in hotels, restaurants or cafeterias.

Without requiring any brickwork, and the fact they are considered collapsible structures allows for quick and easy installation.

A wide range of colours and finishes, as well as accessories and complementary items, enable the creation of new and attractive spaces for your clients to enjoy being outdoors in any season of the year, at any time of day.





Prescription and projects

# A must in the new architecture

The installation of this product is quick and practically non-invasive, with no need for masonry work. This makes our bioclimatic pergolas the star solution in terms of sun protection and enclosure systems.

Architects and designers all over the world are including Saxun pergolas in all types of architectural projects, both new and refurbished, whether on penthouse terraces or in the gardens of single-family homes.

P-190 and P-150 are indispensable systems for projects of all sizes in the hotel and catering industry.

To this end, we provide all the necessary resources so that designers can include these products in the initial phase of the project; BIM files, dwg and prescription sheets to conceptualise new spaces from the very beginning.

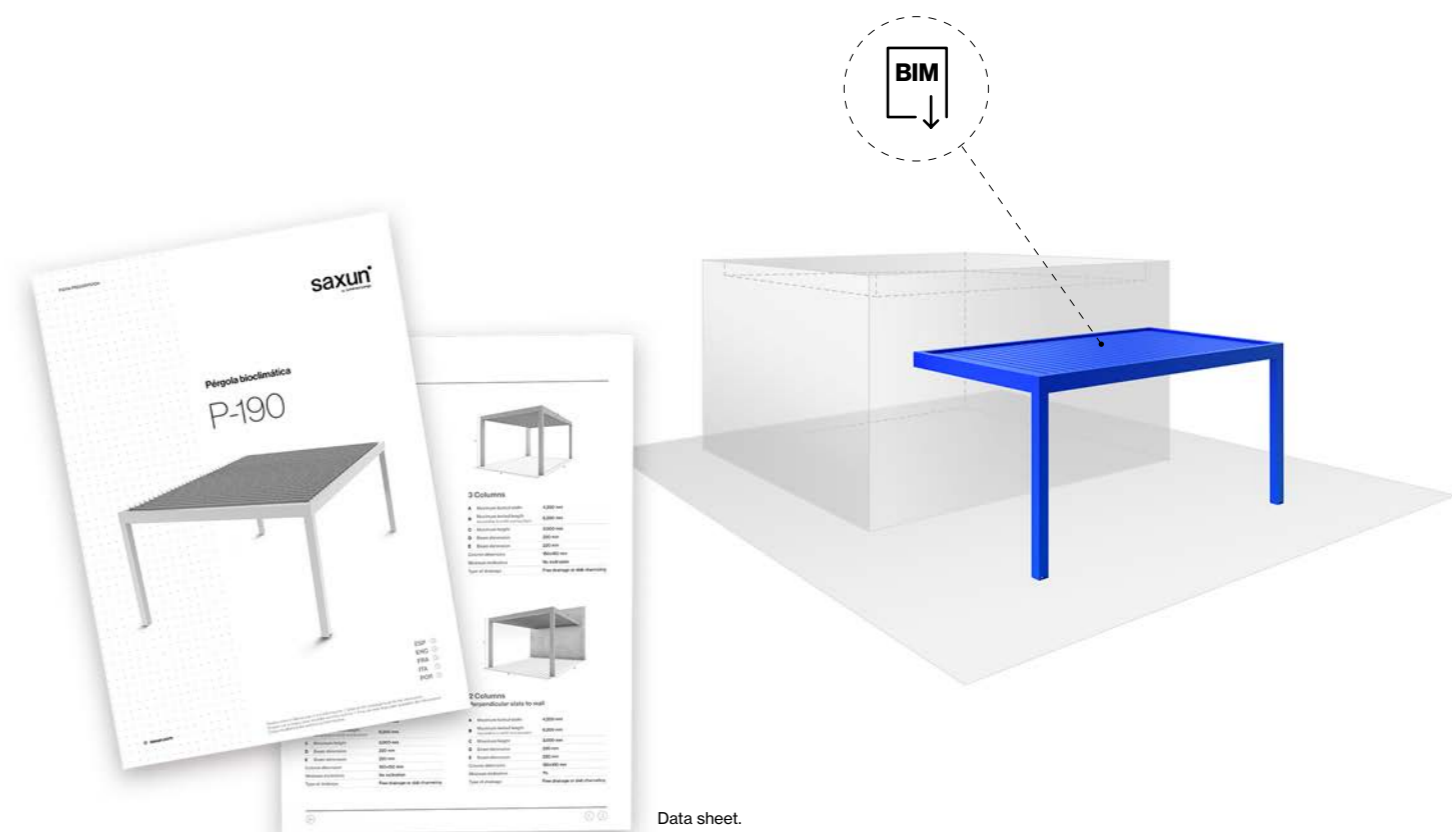

Data sheet.



# A universe full of possibilities

The stability and robustness of this extruded aluminium structure allows the installation of other Saxun solutions to increase the possibilities of your space.

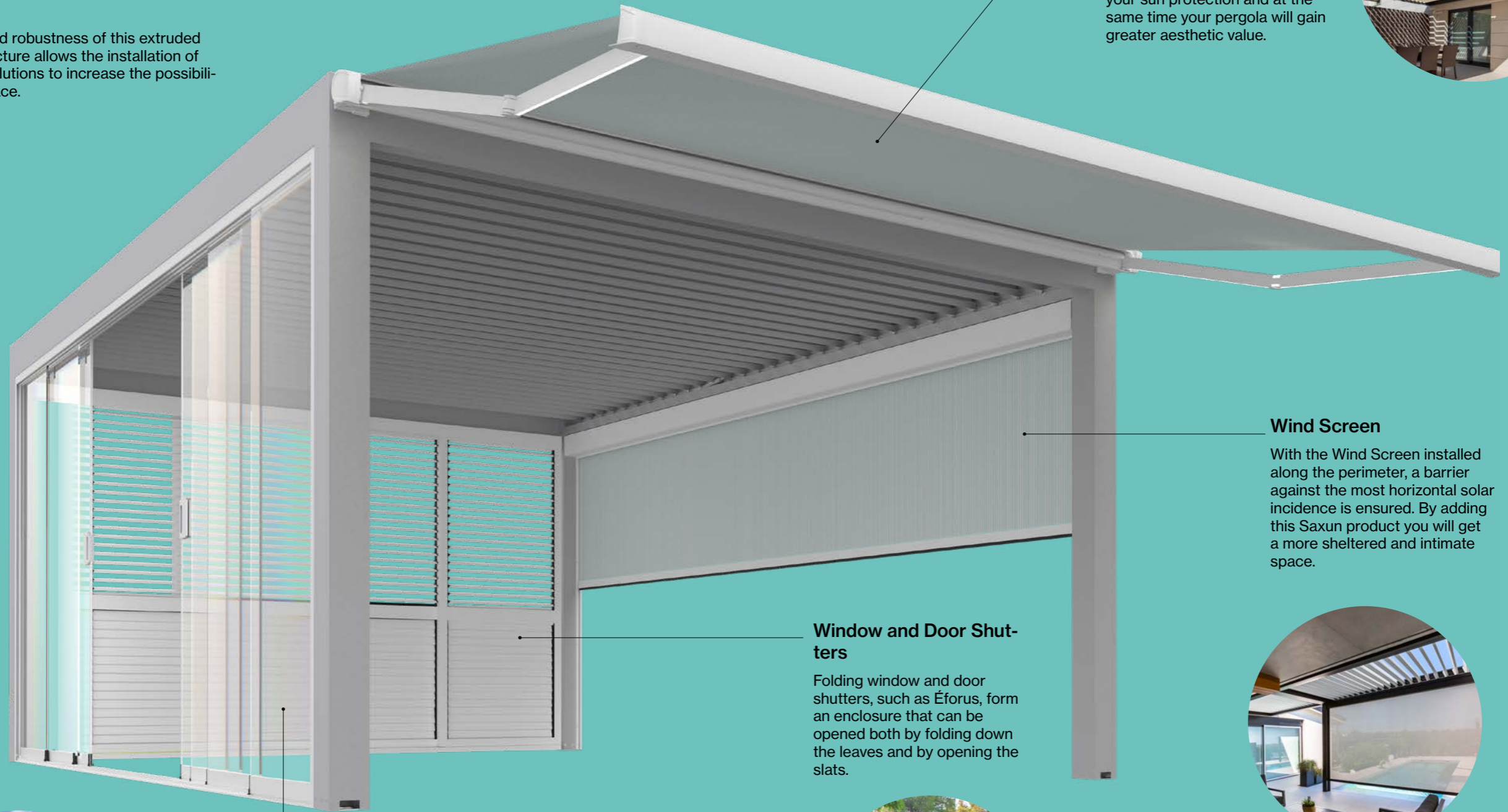

### Awning

The installation of cassette awnings, such as Kiara, will extend your sun protection and at the same time your pergola will gain greater aesthetic value.

### Wind Screen

With the Wind Screen installed along the perimeter, a barrier against the most horizontal solar incidence is ensured. By adding this Saxun product you will get a more sheltered and intimate space.

### Window and Door Shutters

Folding window and door shutters, such as Éforus, form an enclosure that can be opened both by folding down the leaves and by opening the slats.



### Glass sliding window

For all those sheltered spaces where we don't want to lose one iota of visibility to the outside, the Astron glass sliding window is the solution of choice.



# Smart comfort

## Controls

By pressing the button on your transmitter, you can control the entry of light and air as you wish. Our controls offer a modern and refined design that blends perfectly into any space. They allow you to configure the operation of one or more elements, in the usage scenarios you want.

## Automation



Sunis II Sun Sensor

The slats will open or close depending on the inclination of the sun's rays, protecting us under the pergola.



Eolis Wind Sensor io

In the event of wind pressure, the louvres open when the wind speed exceeds the programmed value.



Ondeis Rain Catcher

This sensor allows the slats to close automatically when rain is detected, so that users, furniture and everything under the pergola will be protected automatically.

\* Installation by the client.

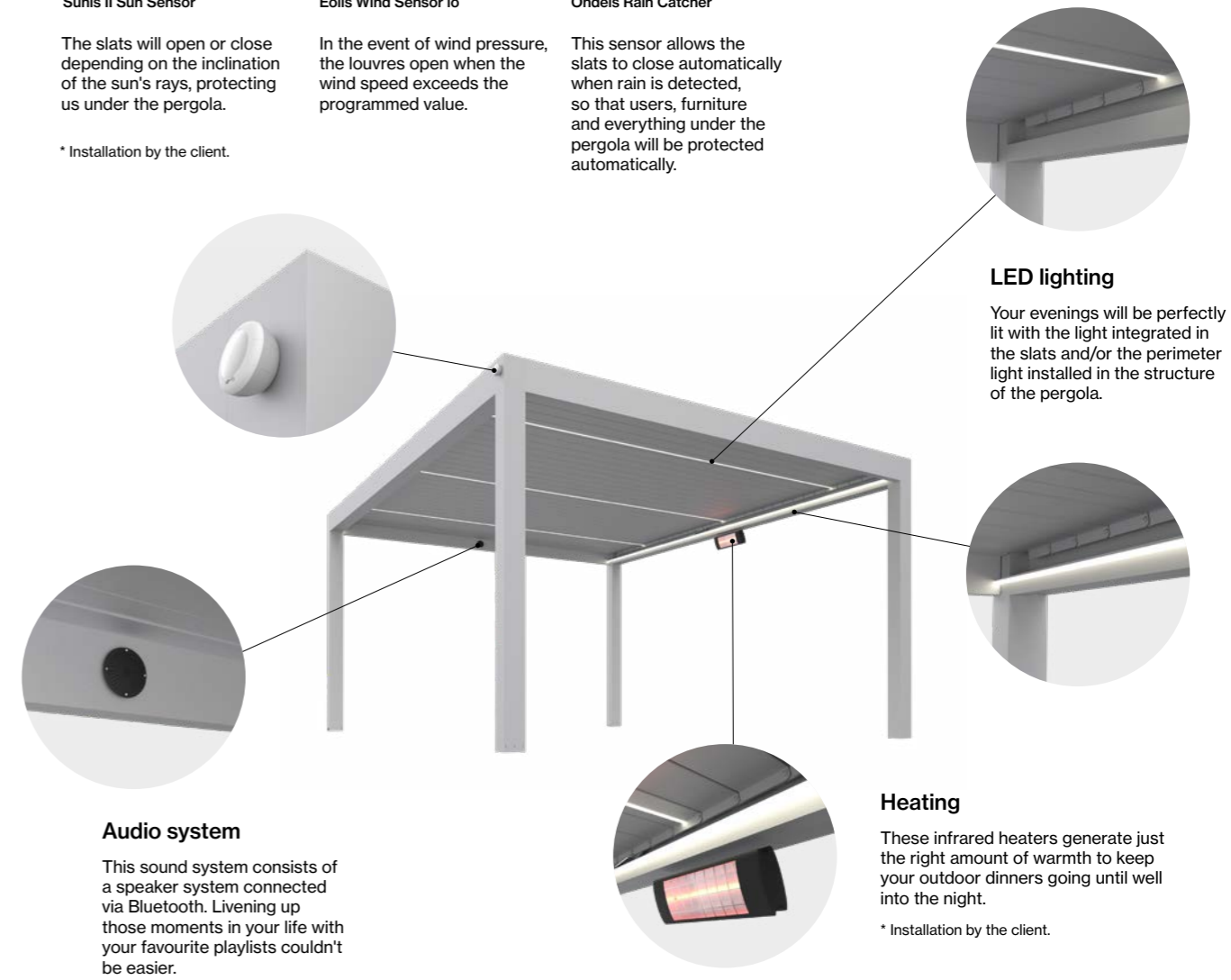

### LED lighting

Your evenings will be perfectly lit with the light integrated in the slats and/or the perimeter light installed in the structure of the pergola.

### Audio system

This sound system consists of a speaker system connected via Bluetooth. Livening up those moments in your life with your favourite playlists couldn't be easier.

### Heating

These infrared heaters generate just the right amount of warmth to keep your outdoor dinners going until well into the night.

\* Installation by the client.



## Smart Home

Using the wifi connection, you can control your pergola, as well as all the accessories and automation applications included in it.

It is possible to create scenarios based on your habits to make your life easier.

Colours and finishes

# Your pergola, the way you imagine it

To adapt to all aesthetic requirements or to create totally disruptive spaces, the choice of colour is fundamental. This is why your Saxun pergola has no limits; you can choose any colour from the RAL chart, anodised colours and woods, in glossy, matt and textured finishes (for even greater weather resistance).

A customised finish that guarantees excellent performance against solar radiation, rain or snow, thanks to the quality of the aluminium, the paint used, and the lacquering process itself.

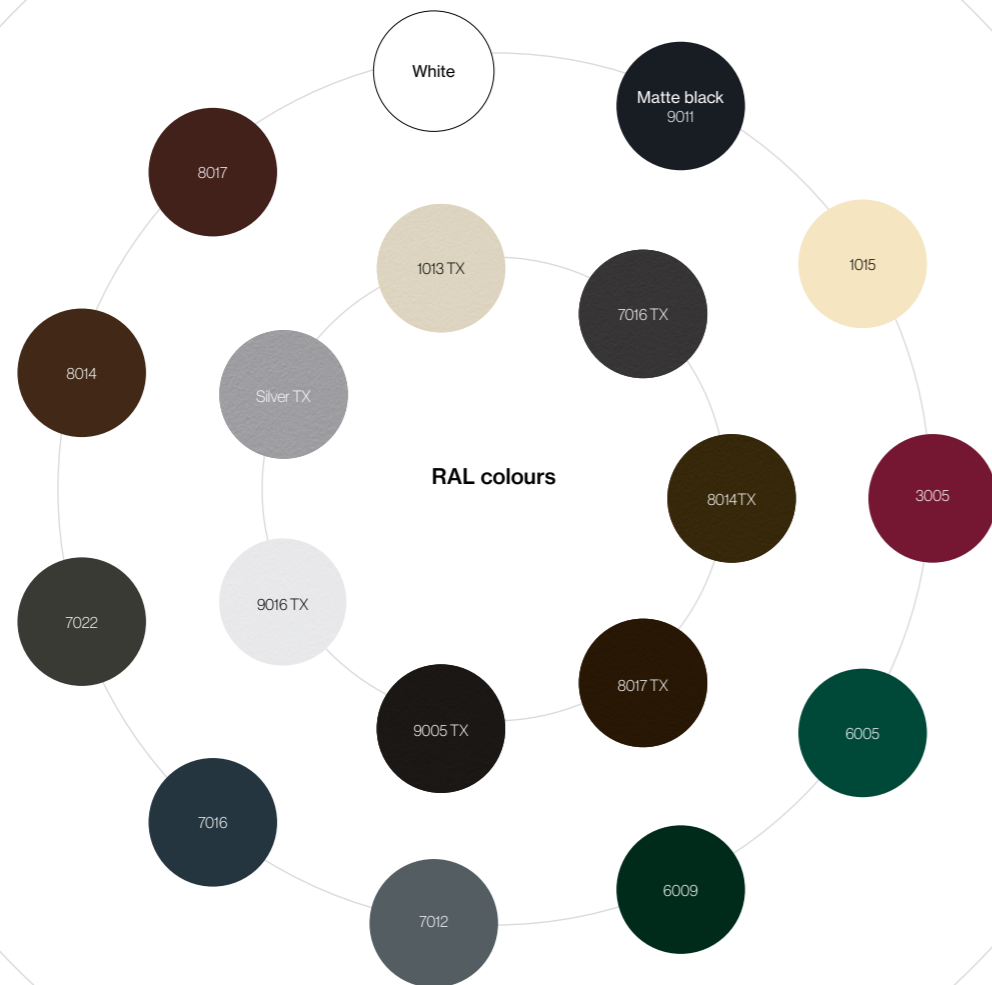

The shades of these colour are for guidance only. There could be a difference with the actual colour due to the printing process.

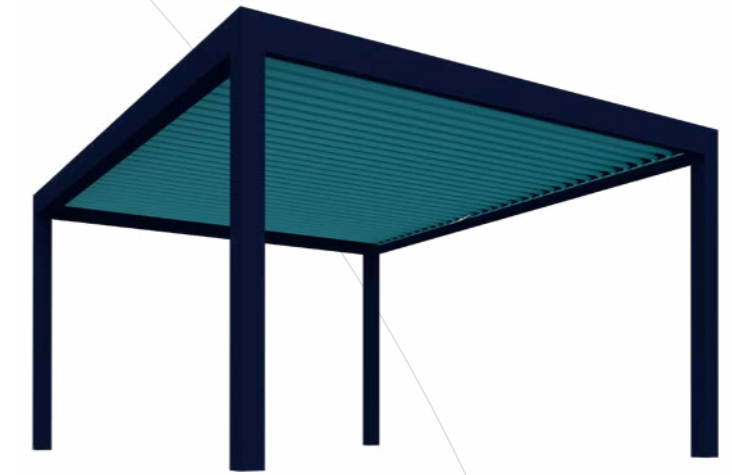

Our state-of-the-art lacquering process is based on Qualicoat prescriptions (international quality seal for lacquered aluminium that guarantees its quality for use in architecture) and allows a wide variety of processes and high-performance finishes that adapt to every requirement:

- General multi-metal process (not Qualicoat).
- Equivalent to standard Qualicoat.
- For installations exposed to the sea, we can offer a superior quality of Qualicoat, which is the Seaside Class. Within this classification, the AA1 fully coincides with the Qualimarine seal, awarded by the French Association (ADAL).





Saxun offers the widest range of enclosures, solar protection and decorative treatments on the market to improve the spaces in your life, accommodating your needs and style, so that you can feel secure and at ease.

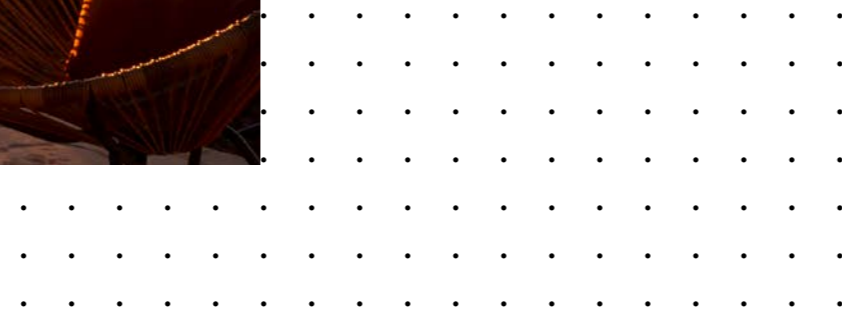

**saxun**<sup>®</sup>  
by Giménez Ganga

**Giménez Ganga, S.L.U.**  
Polígono Industrial El Castillo  
C/ Roma, 4  
03630 • Sax (Alicante) • Spain

**saxun.com**

Your world,  
our universe.

